

2/S7
v 2.6 (hr)

STROPNI KRILASTI DISTRIBUTER

DK

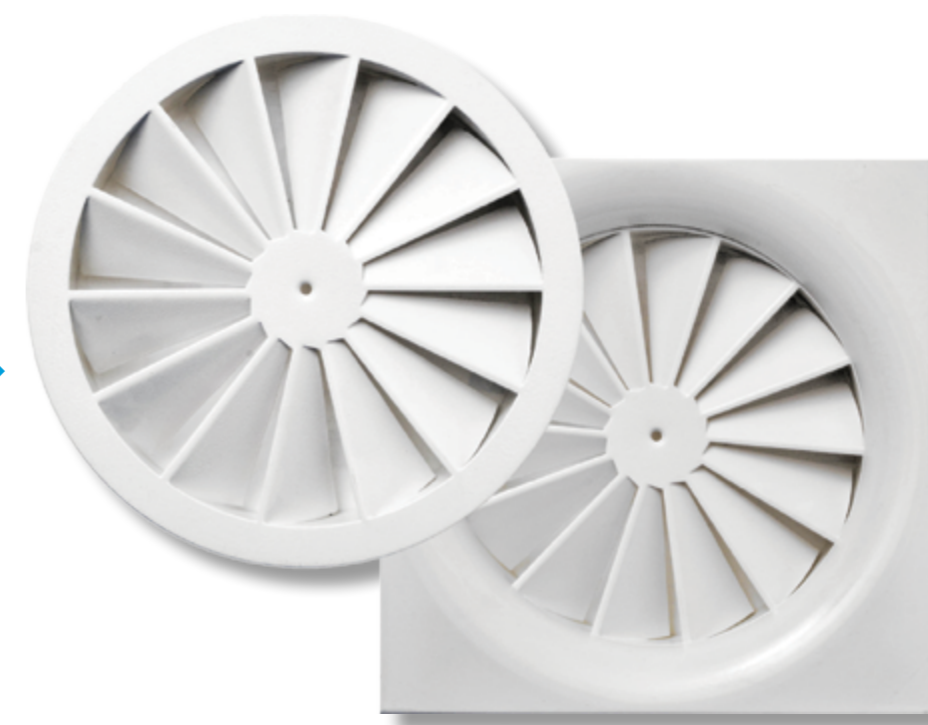

SADRŽAJ

Stropni krilasti distributer, tip DK.....	115
Oznaka za narudžbu.....	116
Izborni dijagrami.....	116
Slika istrujavanja.....	121

DK

- Stropni distributer za visine ugradnje od 2,6 do 4m
- Istrujna ploča je izrađena od čeličnog lima i plastificirana u bijeloj boji, RAL 9010
- Distributer ovog tipa namijenjen je za dovod zraka pri grijanju i hlađenju.
- Fiksna krilca
- Ugradnja centralnim vijkom

Opcije

- Prikjučna kutija
- Okrugla ili kvadratna izvedba

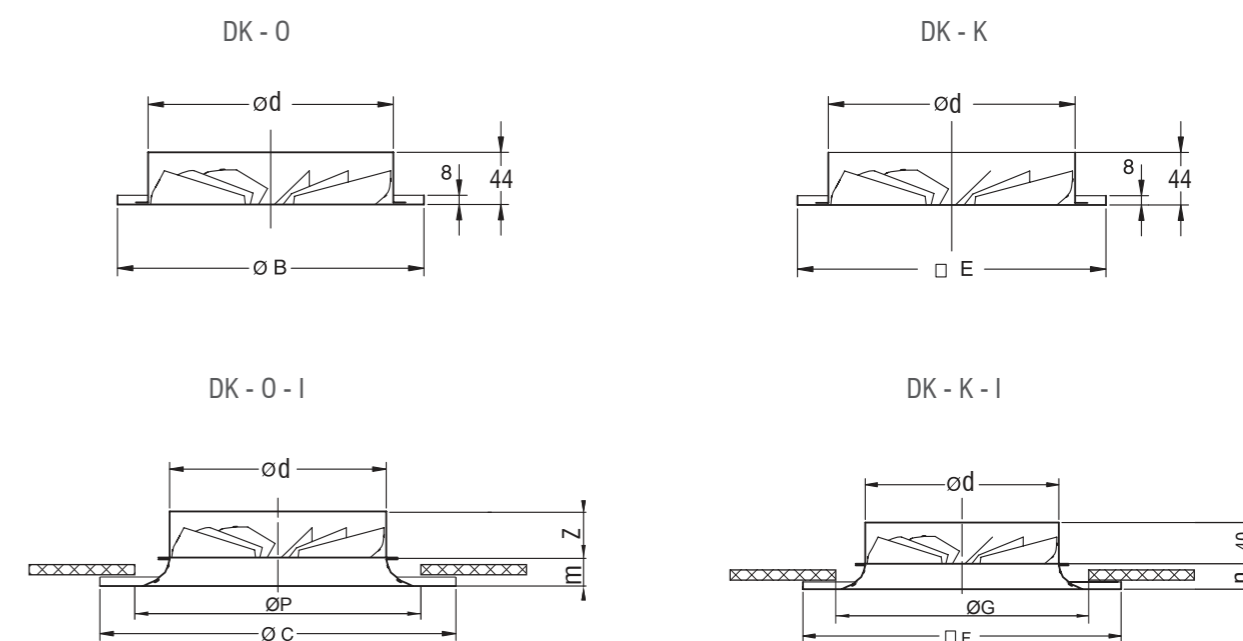
Tipovi i dimenzije anemostata

**Minimalni otvor u stropu: øP - za okruglu izvedbu sa tlačnim ušćem
øG - za kvadratnu izvedbu sa tlačnim ušćem

Dimenzije distributera

Velicina	ød [mm]	øB [mm]	øC [mm]	m [mm]	øP [mm]	øE [mm]	øF [mm]	n [mm]	øG [mm]	Z [mm]	UPK2
125	123	178	200	25	180	178	198	17	180	50	300/ø98
160	158	195	250	25	215	195	248	17	190	50	300/ø123
200	198	248	300	25	255	248	248	17	230	50	300/ø158
250	248	296	350	25	305	296	298	17	280	50	500/ø198
315	313	363	450	35	395	363	398	27	350	50	600/ø248
400	398	600	570	60	535	600	594	52	570	65	625/ø313

Oznake:

V [m ³ /h]	- protok zraka	v _h [m/s]	- srednja brzina mlaza između dva distributera na udaljenosti h
V _{uk} [m ³ /h]	- ukupna količina zraka u kretanju	Δp [Pa]	- ukupni pad tlaka
h [m]	- udaljenost između zone boravka i ravnine istrujavanja	t _p [°C]	- temperatura zraka u prostoriji
H [m]	- visina prostorije	t _z [°C]	- temperatura dobavnog zraka
A, B [m]	- razmak između anemostata	t _L [°C]	- Temperatura mlaza zraka na udaljenosti L
x [m]	- udaljenost od zida	Δt _z [°C]	- (t _z - t _p)
L [m]	- ukupni domet mlaza (x+h)	Δt _L [°C]	- (t _L - t _p)
A _{ef} [m ²]	- efektivna istrujna površina	i	- indukcija V _{uk} /V
v _{ef} [m/s]	- efektivna istrujna brzina	L _{WA} [dB(A)]	- razina zvučne snage
v _L [m/s]	- srednja brzina mlaza na udaljenosti L od difuzora		

Oznaka za narudžbu:

Tip	DK - O - I - 250 - A - H - ød - Z
K - kvadratna ploča	
O - okrugla ploča	
Tlačno ušće	
Nazivna veličina	
A - dovod zraka	
B - odvod zraka	
H - horizontalni priključak	
V - vertikalni priključak	
Promjer priključka	
Izolacija	

*Oznaka za narudžbu priključne kutije na stranici 184
 **amo za plitku kutiju UPK2

IZBORNI DIJAGRAMI

Dijagram razine buke i pada tlaka DK - I 125

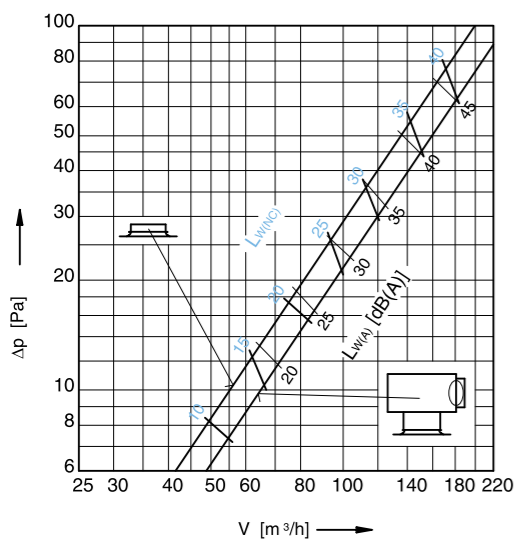

Dijagram razine buke i pada tlaka DK 125

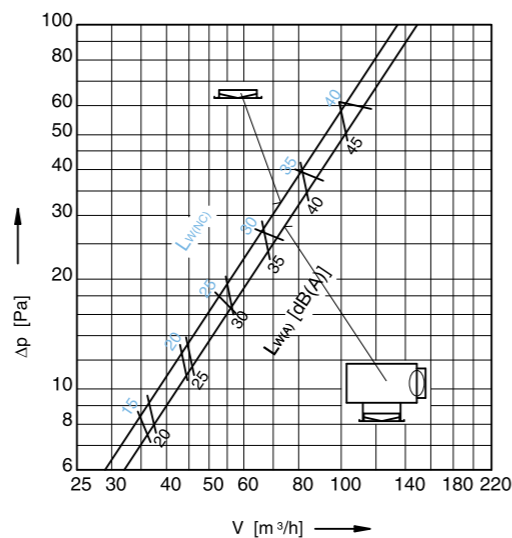

Dijagram razine buke i pada tlaka DK - I 160

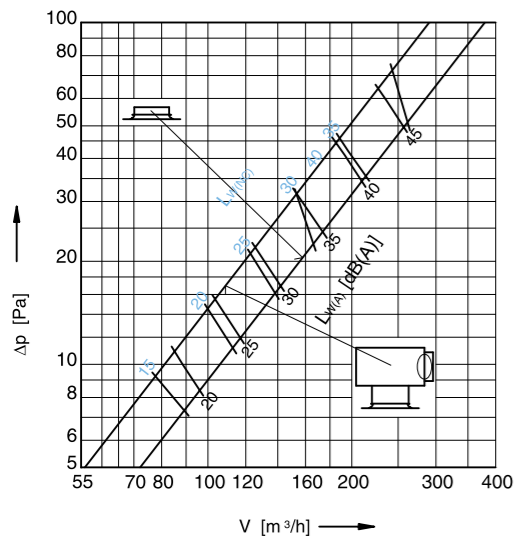

Dijagram razine buke i pada tlaka DK 160

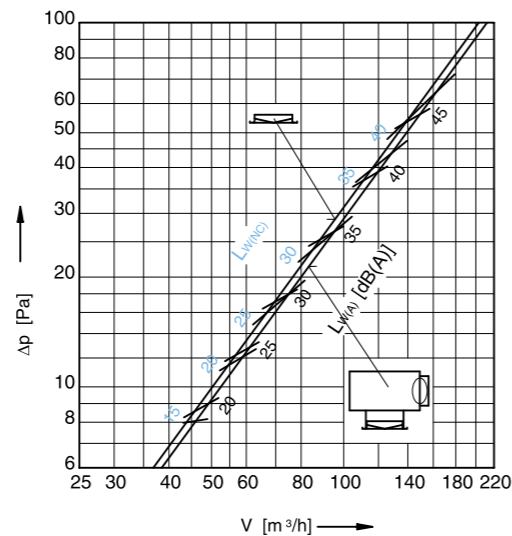

Dijagram razine buke i pada tlaka DK 200 - I

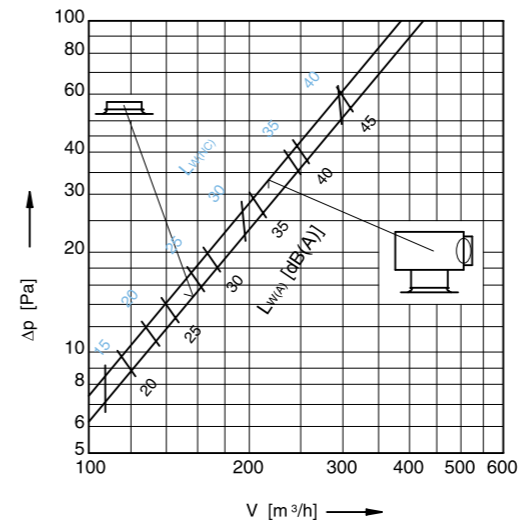

Dijagram razine buke i pada tlaka DK 200

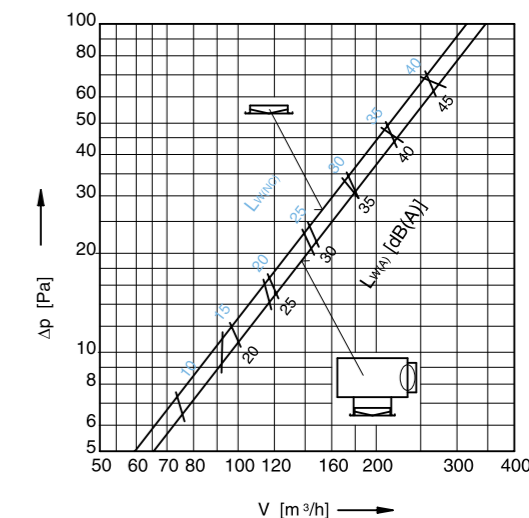

Dijagram razine buke i pada tlaka DK 250 - I

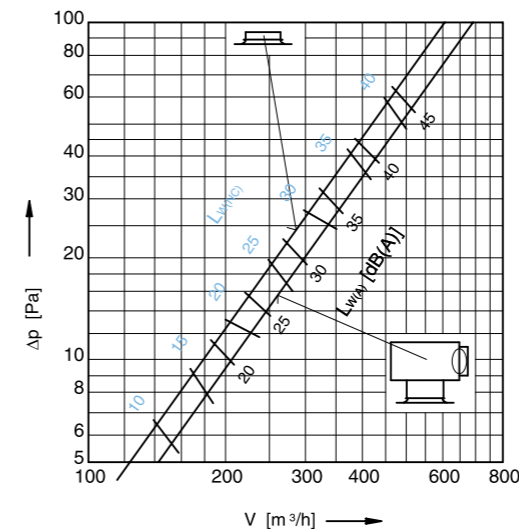

Dijagram razine buke i pada tlaka DK 250

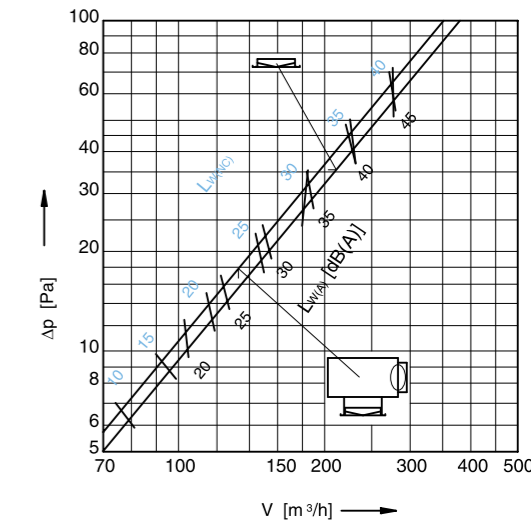

Dijagram razine buke i pada tlaka DK 315 - I

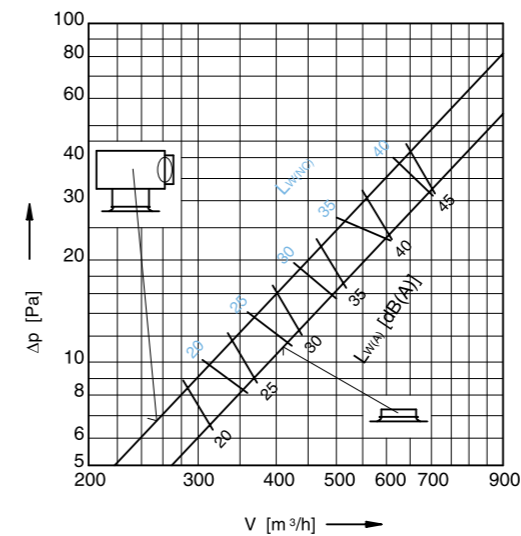

Dijagram razine buke i pada tlaka DK 315

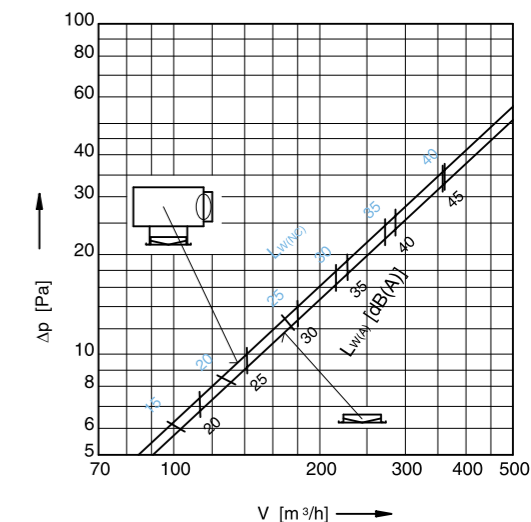

Raspored difuzora - DK 125
(u više od jednog reda, ako je B = 2,80 m)

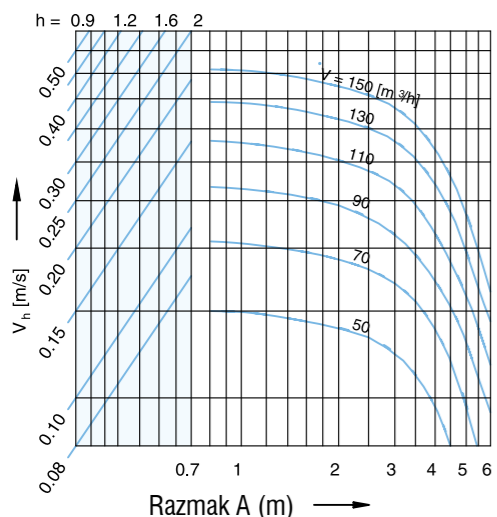

Raspored difuzora - DK 125
(u jednom ili više redova, ako je B ≥ 4,00 m)

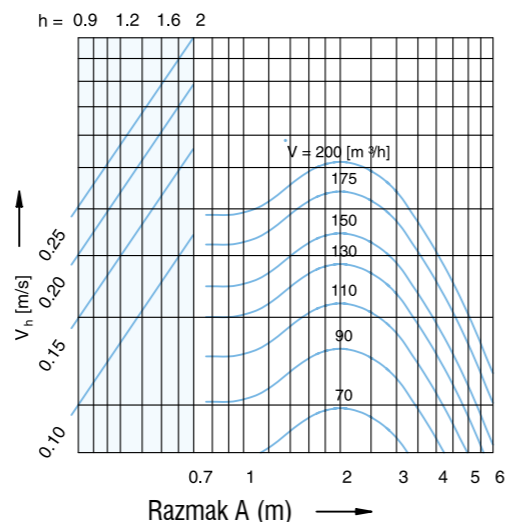

Brzina zraka uz zid - DK 160

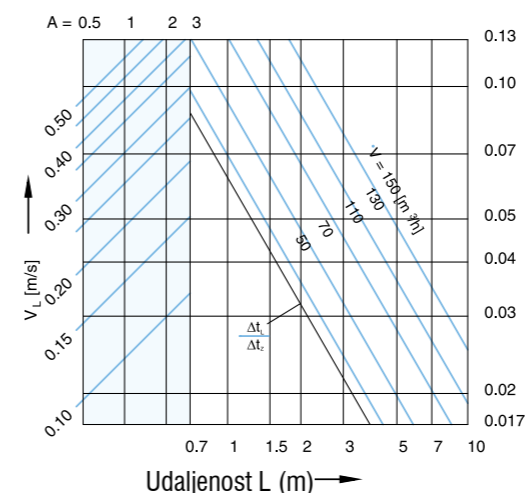

Brzina zraka uz zid - DK 160

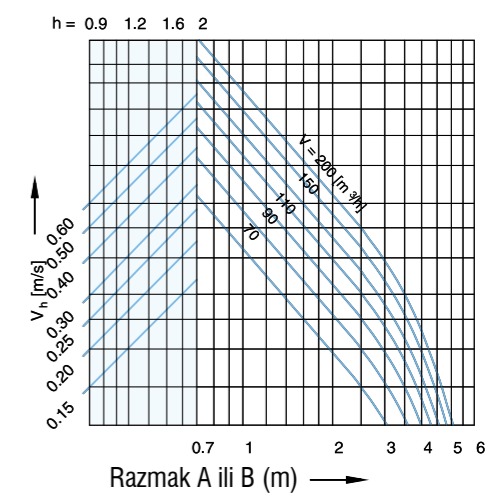

Brzina zraka uz zid - DK 125

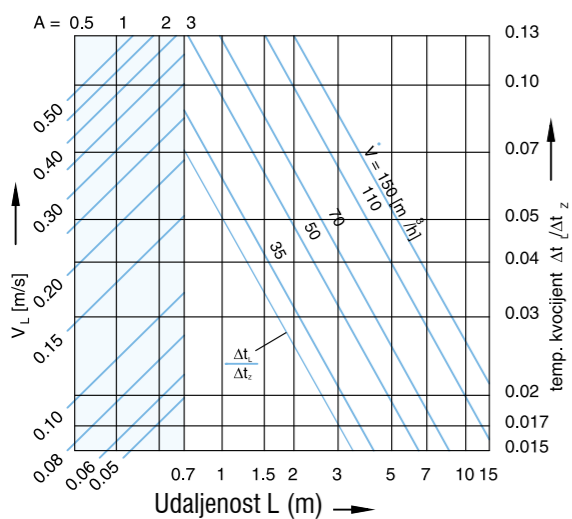

Kvadratni difuzor - DK 125

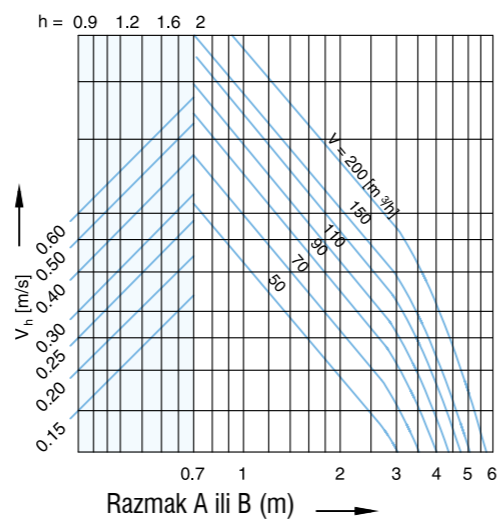

Raspored difuzora - DK 200
(u više od jednog reda, ako je B = 2,80 m)

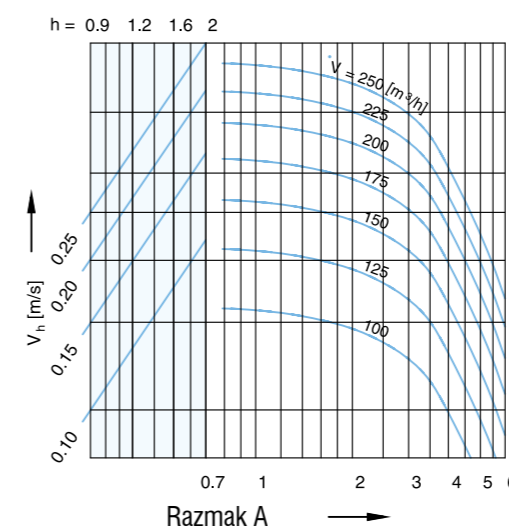

Raspored difuzora - DK 200
(u jednom ili više redova, ako je B ≥ 4,00m)

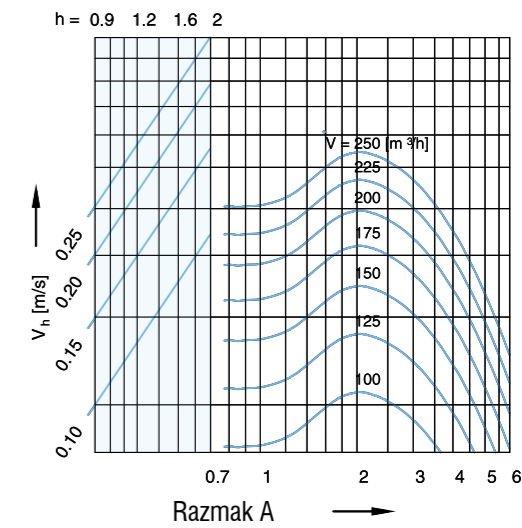

Raspored difuzora - DK 160
(u više od jednog reda, ako je B = 2,80 m)

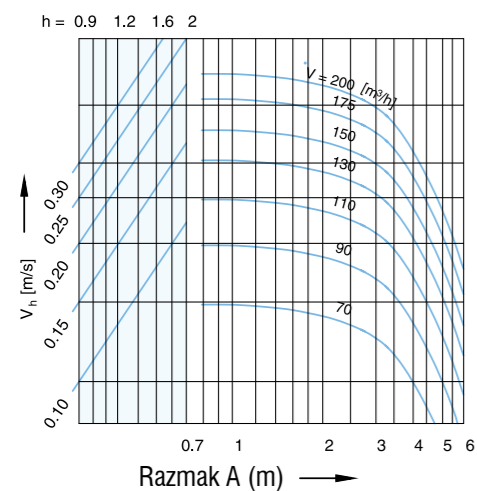

Raspored difuzora - DK 160
(u jednom ili više redova, ako je B ≥ 4,00 m)

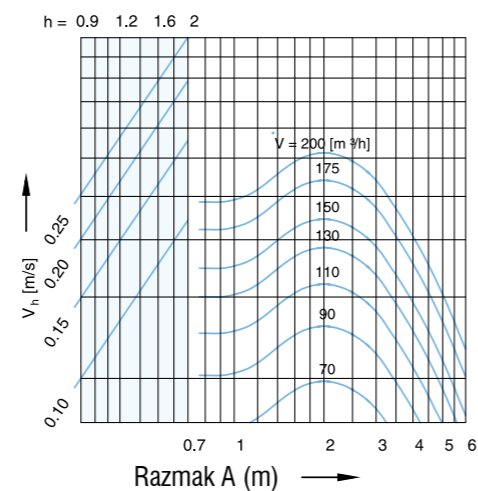

Brzina zraka uz zid - DK 200

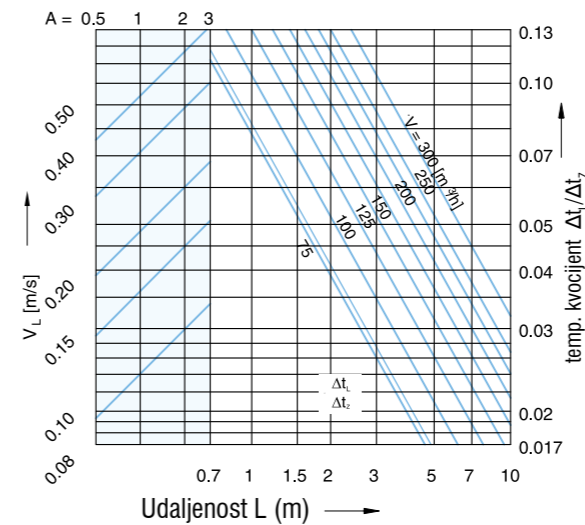

Kvadratni difuzor - DK 200

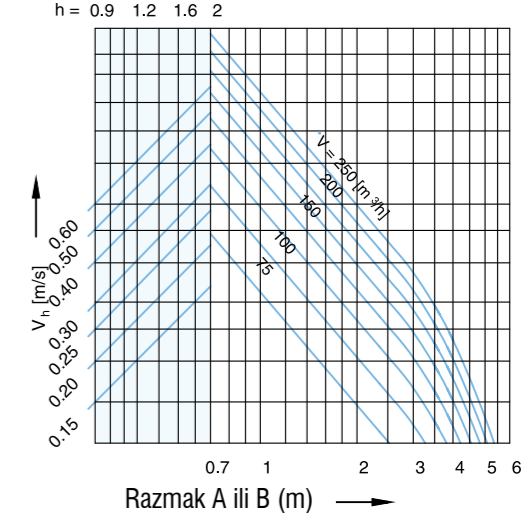

STROPNI KRILASTI DISTRIBUTER

STROPNI KRILASTI DISTRIBUTER

Raspored difuzora - DK 250
(u više od jednog reda, ako je B = 2,80 m)

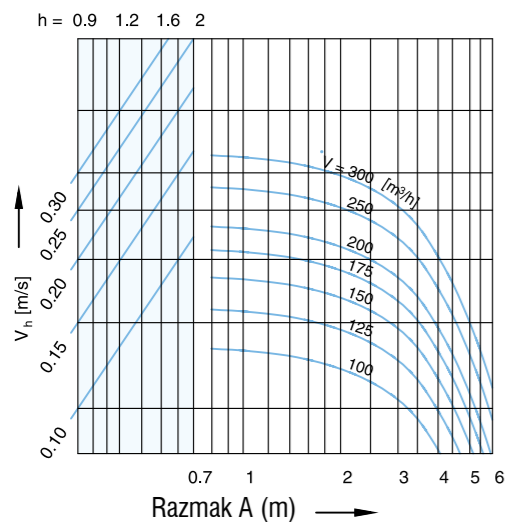

Raspored difuzora - DK 250
(u jednom ili više redova, ako je B ≥ 4,00 m)

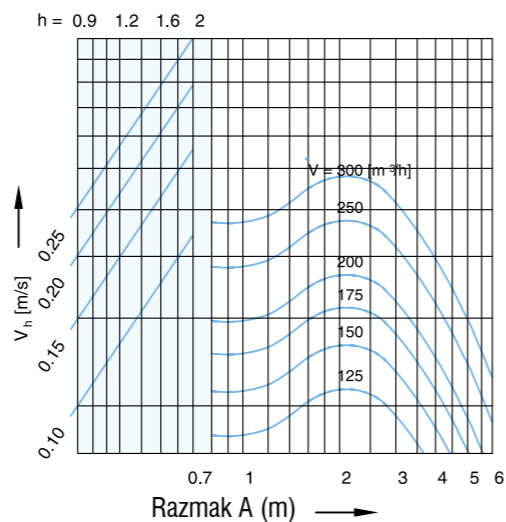

Brzina zraka uz zid - DK 315

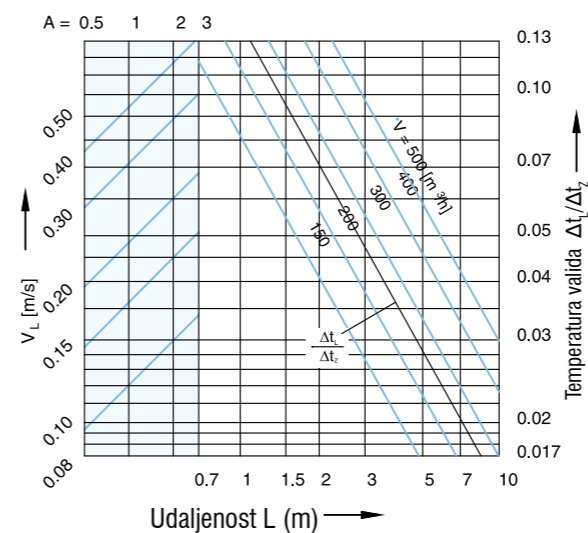

Kvadratni difuzor - DK 315

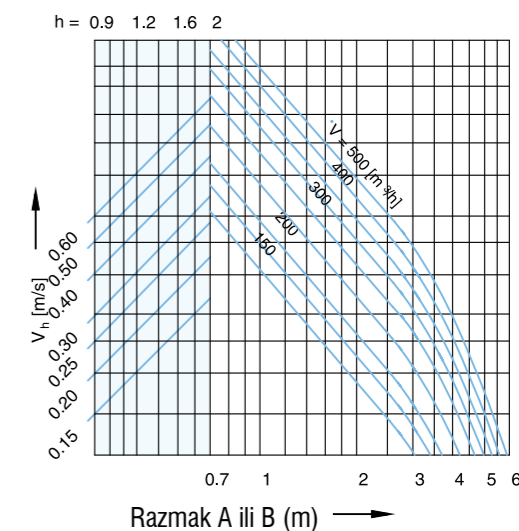

Brzina zraka uz zid - DK 250

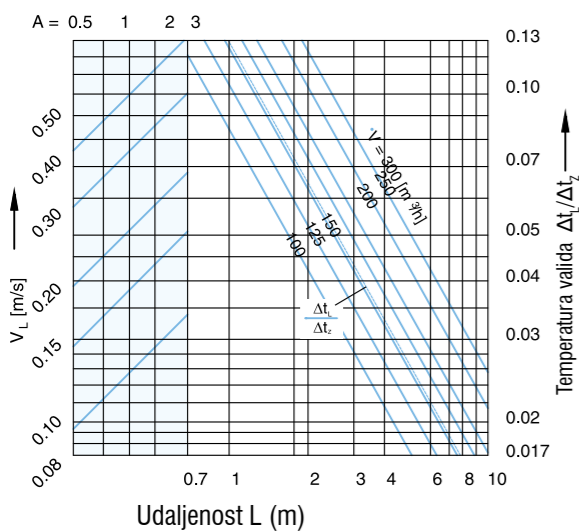

Kvadratni difuzor - DK 250

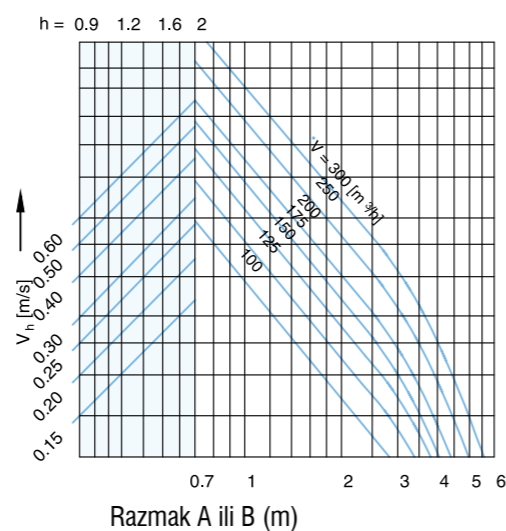

SLIKA ISTRUJAVANJA

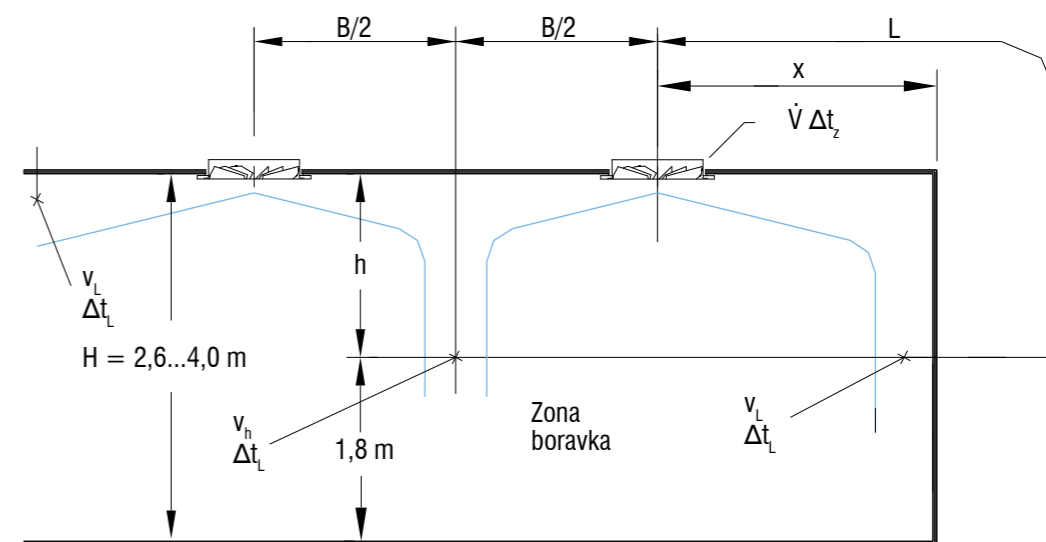

Raspored difuzora - DK 315
(u više od jednog reda, ako je B = 2,80 m)

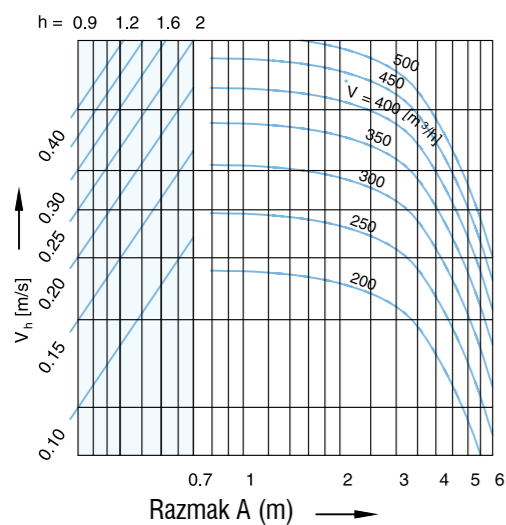

Raspored difuzora - DK 315
(u jednom ili više redova, ako je B ≥ 4,00 m)

